



# JBL PARTYBOX 520



**OWNER'S MANUAL**

## IMPORTANT SAFETY INSTRUCTIONS

### For all products:

1. Clean only with a dry cloth.
2. Do not block any ventilation openings. Install this apparatus in accordance with the manufacturer's instructions.
3. Do not install this apparatus near any heat sources such as radiators, heat registers, stoves or other apparatus (including amplifiers) that produce heat.
4. Do not defeat the safety purpose of the polarized or grounding-type plug. A polarized plug has two blades with one wider than the other. A grounding-type plug has two blades and a third grounding prong. The wide blade or the third prong is provided for your safety. If the provided plug does not fit into your outlet, consult an electrician for replacement of the obsolete outlet.
5. Protect the power cord from being walked on or pinched, particularly at plugs, convenience receptacles and the point where they exit from the apparatus.
6. Use only attachments/accessories specified by the manufacturer.
7. Use only with the cart, stand, tripod, bracket or table specified by the manufacturer or sold with the apparatus. When a cart is used, use caution when moving the cart/apparatus combination to avoid injury from tip-over. 
8. Unplug this apparatus during lightning storms or when unused for long periods of time.
9. Refer all servicing to qualified service personnel. Servicing is required when the apparatus has been damaged in any way, such as when the power-supply cord or plug is damaged, liquid has been spilled or objects have fallen into the apparatus, or the apparatus has been exposed to rain or moisture, does not operate normally or has been dropped.
10. To disconnect this apparatus from the AC mains completely, disconnect the power-supply cord plug from the AC receptacle.
11. The mains plug of the power-supply cord shall remain readily operable.
12. This apparatus is intended to be used only with the power supply and/or charging cable provided by the manufacturer.

**The following instructions may not apply to waterproof devices. Refer to your device user manual or quick start guide for more waterproof instruction if any.**

- Do not use this apparatus near water.
- Do not expose this apparatus to dripping or splashing, and ensure that no objects filled with liquids, such as vases, are placed on the apparatus.

### WARNING:

- TO REDUCE THE RISK OF FIRE OR ELECTRIC SHOCK, DO NOT EXPOSE THIS APPARATUS TO RAIN OR MOISTURE.

## CAUTION

### RISK OF ELECTRIC SHOCK. DO NOT OPEN.



THIS SYMBOL ON THE PRODUCT MEANS THERE IS UNINSULATED, DANGEROUS VOLTAGE WITHIN THE PRODUCT ENCLOSURE THAT MAY PRESENT A RISK OF ELECTRICAL SHOCK.



THIS SYMBOL ON THE PRODUCT MEANS THERE ARE IMPORTANT OPERATING AND MAINTENANCE INSTRUCTIONS IN THIS GUIDE.

### CAUTION FCC AND IC STATEMENT FOR USERS

This device complies with part 15 of the FCC Rules. Operation is subject to the following two conditions: (1) This device may not cause harmful interference, and (2) this device must accept any interference received, including interference that may cause undesired operation.

CAN ICES(B)/NMB(B)

### FCC SDOC SUPPLIER'S DECLARATION OF CONFORMITY

HARMAN International hereby declares that this equipment is in compliance with the FCC Part 15 Subpart B.

### Federal Communication Commission Interference Statement

This equipment has been tested and found to comply with the limits for a Class B digital device, pursuant to Part 15 of the FCC Rules. These limits are designed to provide reasonable protection against harmful interference in a residential installation. This equipment generates, uses and can radiate radio frequency energy and, if not installed and used in accordance with the instructions, may cause harmful interference to radio communications. However, there is no guarantee that interference will not occur in a particular installation. If this equipment does cause harmful interference to radio or television reception, which can be determined by turning the equipment off and on, the user is encouraged to try to correct the interference by one or more of the following measures:

- Reorient or relocate the receiving antenna.
- Increase the separation between the equipment and receiver.
- Connect the equipment into an outlet on a circuit different from that to which the receiver is connected.
- Consult the dealer or an experienced radio/TV technician for help.

### Caution:

- Changes or modifications not expressly approved by HARMAN could void the user's authority to operate the equipment.

### For Products That Transmit RF Energy:

**(i) This device contains licence-exempt transmitter(s)/ receiver(s) that comply with Innovation, Science and Economic Development Canada's licence-exempt RSS(s). Operation is subject to the following two conditions:**

1. This device may not cause interference.
2. This device must accept any interference, including interference that may cause undesired operation of the device.

## (ii) Radiation Exposure statement

This equipment complies with FCC and IC RSS-102 radiation exposure limits set forth for an uncontrolled environment.

## For radio equipment operates in 5150-5850MHz

### FCC and IC Caution:

High power radars are allocated as primary users of the 5.25 to 5.35 GHz and 5.65 to 5.85 GHz bands. These radar stations can cause interference with and/or damage to LE LAN (Licence-Exempt Local Area Network) devices. No configuration controls are provided for this wireless equipment allowing any change in the frequency of operations outside the FCC grant of authorization for US operation according to Part 15.407 of the FCC rules.

### IC Caution:

User should also be advised that:

1. The device for operation in the band 5150 - 5250 MHz is only for indoor use to reduce the potential for harmful interference to co-channel mobile satellite systems;
2. The maximum antenna gain permitted for devices in the bands 5250 - 5350 MHz and 5470 - 5725 MHz shall comply with the e.i.r.p. limit: and
3. The maximum antenna gain permitted for devices in the band 5725 - 5825 MHz shall comply with the e.i.r.p. limits specified for point-to-point and non point-to-point operation as appropriate.

**Use Restriction** Attention in European Union, operation is limited to indoor use within the band 5150-5350 MHz.

### Correct disposal of this product (Waste Electrical & Electronic Equipment)

This symbol means the product must not be discarded as household waste, and should be delivered to an appropriate collection facility for recycling. Proper disposal and recycling helps protect natural resources, human health and the environment. For more information on disposal and recycling of this product, contact your local municipality, disposal service, or the shop where you bought this product.



## This product is RoHS compliant.

This product is in compliance with Directive 2011/65/EU and UK The Restriction of the Use of Certain Hazardous Substances in Electrical and Electronic Equipment Regulations 2012, and its amendments, on the restriction of the use of certain hazardous substances in electrical and electronic equipment.

## REACH

REACH (Regulation No 1907/2006) addresses the production and use of chemical substances and their potential impacts on human health and the environment. Article 33(1) of REACH Regulation requires suppliers to inform the recipients if an article contains more than 0.1 % (per weight per article) of any

substance(s) on the Substances of Very High Concern (SVHC) Candidate List ('REACH candidate list'). This product may contain the substance "lead"(CAS-No. 7439-92-1) in a concentration of more than 0.1% per weight.

At the time of release of this product, except for the lead substance, no other substances of REACH candidate list are contained in a concentration of more than 0.1% per weight in this product.

### Note:

- On June 27, 2018, lead was added to the REACH candidate list. The inclusion of lead in the REACH candidate list does not mean that lead-containing materials pose an immediate risk or results in a restriction of permissibility of its use.

## For devices with headphone jacks

### WARNINGS/CAUTIONS



Do NOT use the headphones at a high volume for any extended period.

- To avoid hearing damage, use your headphones at a comfortable, moderate volume level.
- Turn the volume down on your device before placing the headphones on your ears, then turn the volume up gradually until you reach a comfortable listening level.

## For Products That Include Batteries

### Instructions for Users on Removal, Recycling and Disposal of Used Batteries

To remove the batteries from your equipment or remote control, reverse the procedure described in the owner's manual for inserting batteries. For products with a built-in battery that lasts for the lifetime of the product, removal may not be possible for the user. In this case, recycling or recovery centers handle the dismantling of the product and the removal of the battery. If, for any reason, it becomes necessary to replace such a battery, this procedure must be performed by authorized service centers. In the European Union and other locations, it is illegal to dispose of any battery with household trash. All batteries must be disposed of in an environmentally sound manner. Contact your local waste-management officials for information regarding the environmentally sound collection, recycling and disposal of used batteries.

### WARNING:

- Danger of explosion if battery is incorrectly replaced. To reduce risk of fire, explosion or leakage of flammable liquid/gas, don't disassemble, crush, puncture, short external contacts, expose to temperature above 60°C (140°F), sunshine or like, expose to extremely low air pressure or dispose of in fire or water. Replace only with specified batteries. The symbol indicating 'separate collection' for all batteries and accumulators shall be the crossed-out wheeled bin shown below:



## **WARNING - For Products Contain Coin/Button Cell Batteries**

DO NOT INGEST BATTERY, CHEMICAL BURN HAZARD. This product contains a coin/button cell battery. If the coin/button cell battery is swallowed, it can cause severe internal burns in just 2 hours and can lead to death. Keep new and used batteries away from children. If the battery compartment does not close securely, stop using the product and keep it away from children. If you think batteries might have been swallowed or placed inside any part of the body, seek immediate medical attention.

### **For All Products with Wireless Operation:**

HARMAN International hereby declares that this equipment is in compliance with the essential requirements and other relevant provisions of Directive 2014/53/EU and UK Radio Equipment Regulations 2017. The declaration of conformity may be consulted in the specs section of the product detail page, accessible from [www.jbl.com](http://www.jbl.com) or in [www.jbl.com/doc](http://www.jbl.com/doc).

## **EPILEPSY WARNING**

**A few people may experience epileptic seizures when viewing flashing lights.**

## **Precautions**

### **Stand Mounting Safety Precautions**

**Always follow instruction and precaution advice from speaker stand manufacturer.**

This speaker contains a mounting hole that allows it to be mounted on the 35 mm pole of tripod stands or on a 35 mm pole over subwoofers. When using stands or poles, be sure to observe the following precautions:

- Check the stand or pole specification to be certain the device is designed to support the weight of the speaker. Observe all safety precautions specified by the manufacturer.
- Always verify that the stand (or subwoofer/pole) is placed on a flat, level and stable surface and be sure to fully extend the legs of tripod type stands. Position the stand so that the legs do not present a trip hazard.
- Use this floor stand only on a flat, solid surface. Once the support (extended leg) has been placed and adjusted, carefully tighten the screws and use the safety pin. After placing the speaker on the stand, check for stability: When tilting each direction to 10 degrees (for the surface), the speaker height should not turn off. If necessary, reduce the height of the speakers and extend the base of the stand.
- Route cables so that performers, production crew, and audience will not trip and topple the speakers over.
- Inspect the stand (or pole and associated hardware) before each use and do not use equipment with worn, damaged or missing parts.
- Do not attempt to place more than one PARTYBOX series speaker on a stand or pole.
- Always be cautious in windy, outdoor conditions. It may be necessary to place additional weight (i.e. sandbags) on the base of the stand to improve stability. Avoid attaching banners or similar items to any part of a speaker system. Such attachments could act as a sail and topple the system.
- Unless you are confident that you can handle the weight of the speaker, ask another person to help you get it onto the tripod stand or pole.

# TABLE OF CONTENTS

---

## **IMPORTANT SAFETY INSTRUCTIONS 2**

---

## **1. INTRODUCTION 6**

---

## **2. WHAT'S IN THE BOX 6**

---

## **3. PRODUCT OVERVIEW 7**

- 3.1 Top panel 7
  - 3.2 Back panel 8
- 

## **4. PLACEMENT 8**

---

## **5. POWER ON 9**

---

## **6. USING YOUR PARTYBOX 9**

- 6.1 Bluetooth connection 9
  - 6.2 USB connection 10
  - 6.3 Music control 10
  - 6.4 AUX connection 11
  - 6.5 Mixing sound with a microphone and /  
or guitar / line-in device 11
  - 6.6 Charging your mobile device 12
  - 6.7 Replace battery (JBL BATTERY600) 12
- 

## **7. CARRYING YOUR PARTYBOX 12**

---

## **8. POLE-MOUNTING YOUR PARTYBOX 13**

---



---

## **9. ADVANCED USAGE 13**

- 9.1 JBL PARTYBOX app 13
  - 9.2 Light effect 13
  - 9.3 Sound effect 13
  - 9.4 Multi-speaker connection 14
  - 9.5 Daisy chain 14
  - 9.6 Factory reset 14
  - 9.7 IPX4 14
- 

## **10. SPECIFICATIONS 15**

---

## **11. TROUBLESHOOTING 15**

---

## **12. COMPLIANCE 16**

---

## **13. TRADEMARK 16**

---

---

## 1. INTRODUCTION

Congratulations on your purchase! This manual includes information about the **JBL PARTYBOX 520** speaker. We encourage you to take a few minutes to read this manual, which describes the product and includes step-by-step instructions to help you to set up and get started. Read and understand all the safety instructions before using your product.

If you have any questions about this product, its installation or operation, please contact your retailer or customer service, or visit us at [www.jbl.com](http://www.jbl.com).

---

## 2. WHAT'S IN THE BOX

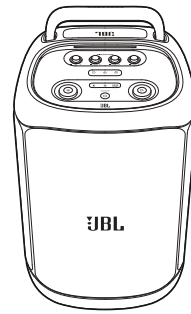

①

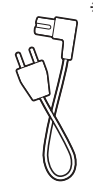

②

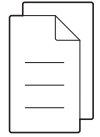

③

- 1) Main unit
- 2) Power cord\*
- 3) Quick Start Guide, Safety Sheet, Warranty Card

\*Power cord quantity and plug type vary by regions.

## 3. PRODUCT OVERVIEW

### 3.1 Top panel

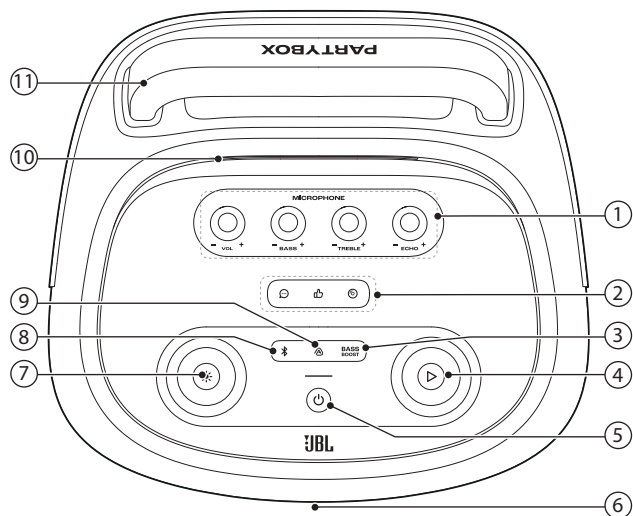

#### 1) Microphone controls

##### - VOL +

- Adjust the microphone volume.

##### - BASS +

- Adjust the bass level.

##### - TREBLE +

- Adjust the treble level.

##### - ECHO +

- Adjust the echo level.

#### 2) Sound effect panel

- Select a special sound effect.

#### 3) **BASS BOOST**

- Enhances the bass level: level 1, level 2, or off.

#### 4) ▷

- Play, pause or resume.
- Rotate clockwise / counterclockwise to increase / decrease the main volume.

#### 5) ⏻

- Turn the power on or off.

#### 6) LED ring

#### 7) ✨

- Press to turn light effect on or off.
- Hold for more than 2 seconds to turn strobe and stary light on or off.
- Rotate clockwise / counterclockwise to switch between different light patterns.

#### 8) 📶

- Press to enter Bluetooth pairing mode.

#### 9) 🔊

- Press to enter multi-speaker connection.

#### 10) Mobile device dock

#### 11) Telescopic handle

##### Caution:

- Do not look directly at the light-emitting parts when the speaker lights are turned on.

#### LED behavior

⏻	○ Solid white	Power on
	○ Dim white	Standby
	○ Off	Power off
📶	⚡ Flashing white quickly	Pairing
	○ Solid white	Connected
	○ Off	Not connected
<b>BASS BOOST</b>	○ Solid white	Level 2
	○ Dim white	Level 1
	○ Off	Off
🔋	🔴 Flashing red quickly	Low battery
	⚡ Flashing white slowly	Charging
	○ Solid white	The speaker is fully charged when the entire light stripe turns solid white.
	○ Solid white	

## 3.2 Back panel

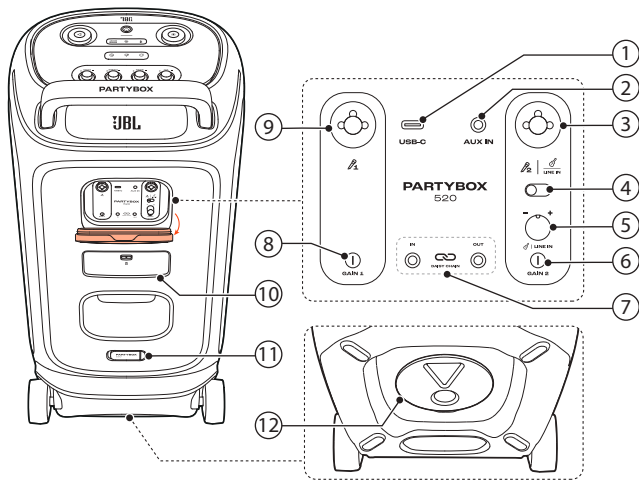

### 1) USB-C

- Connect to a USB storage device.
- Connect to your PC, tablet, or other mobile devices.
- Charge your mobile devices.

### 2) AUX IN

- Connect to an external audio device through a 3.5 mm audio cable (not supplied).

### 3) | | LINE IN

- Connect to a microphone, guitar, or a line-in device such as a DJ mixer.

### 4) Microphone 2/guitar/line-in slider switch

### 5) Guitar/line-in volume knob ( | LINE IN)

- Adjust volume of the guitar or line-in device (if connected).

### 6) GAIN 2

- Adjust gain of the corresponding microphone () or guitar/line-in input.

### 7) DAISSY CHAIN IN/OUT

- Daisy-chain multiple PARTYBOX speakers through 3.5 mm audio cables (not supplied).

### 8) GAIN 1

- Adjust gain of the corresponding microphone () input.

### 9)

- Connect to a microphone.

### 10) Battery compartment

- Pull down the latch to open the battery compartment.

### 11) AC

- Connect to AC power supply.

### 12) Pole-mounting your PARTYBOX

## 4. PLACEMENT

### Caution:

- Do not sit or lean on the speaker or push it sideways to avoid tip-over and possible damages.

Place the speaker on a flat, stable surface and ensure that the rubber feet side is down.

## 5. POWER ON

### Cautions:

- Use the provided power cord only.
- You can use either AC power or the built-in battery as power supply to the speaker.

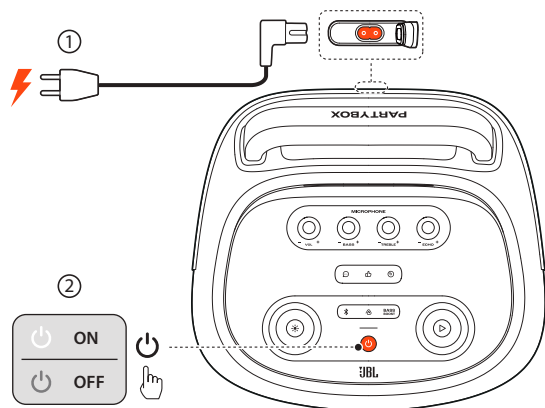

1. Connect AC power.
  - To use the built-in battery, disconnect the AC power after charging the speaker.
2. Press to power on.

### Tips:

- Fully charge the speaker before first-time use to prolong the lifespan of the built-in battery.
- When the speaker is on, you can check the battery level by pressing any button on the speaker.
- The speaker switches to standby mode automatically after 20 minutes of inactivity. You can press on the speaker to switch to normal operation.

## 6. USING YOUR PARTYBOX

### Notes:

- Only one sound source can be played at a time.
- Starting playback from another source will always interrupt the current source.

### 6.1 Bluetooth connection

You can use the speaker with your Bluetooth enabled smartphone or tablet.

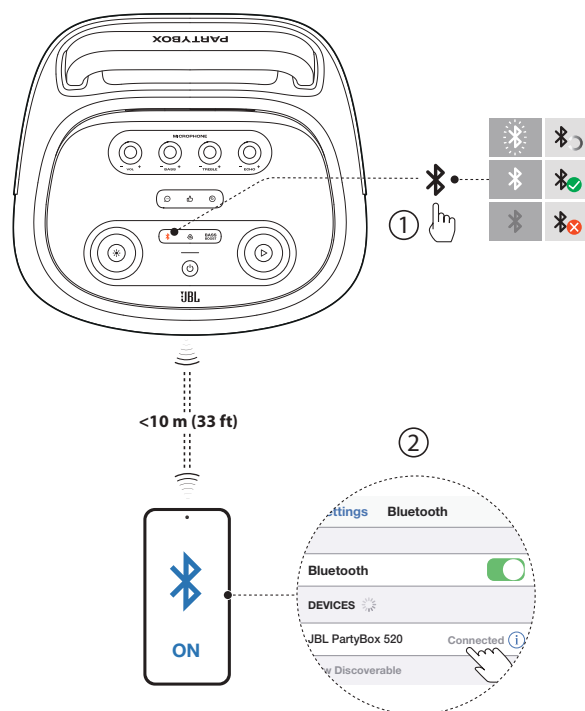

1. Press on the speaker to enter Bluetooth pairing mode.
2. Choose **JBL PartyBox 520** on your Bluetooth device to connect.
3. Once successfully connected, you can stream audio from your Bluetooth device to this speaker.

### Notes:

- This speaker supports multi-point connection. You can pair a second Bluetooth device without disconnecting the first one.
- Enter "0000" if a PIN code is requested for connection to a Bluetooth device.
- Bluetooth performance can be affected by the distance between this product and your Bluetooth device and the environment of operation.

### To terminate the Bluetooth-enabled device:

- Turn off this speaker, or
- Disable Bluetooth on your device.

### To reconnect the Bluetooth enabled device:

- When you turn on this speaker next time, it tries to reconnect the last connected device automatically.
- If not, manually select **JBL PartyBox 520** on your Bluetooth device to connect.

## 6.2 USB connection

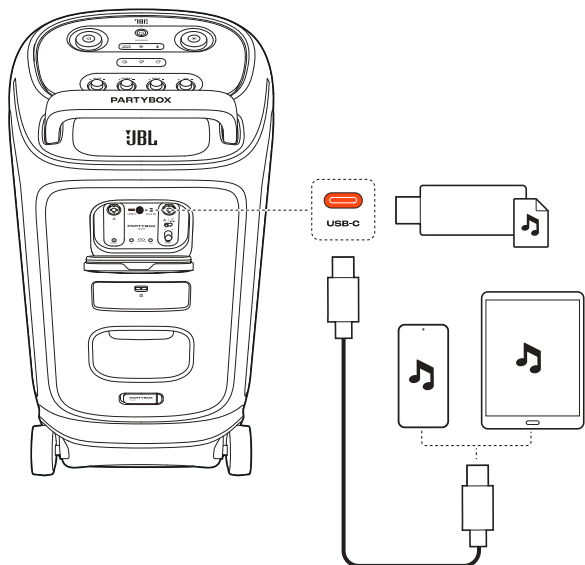

- Connect the speaker with a PC, tablet, or other mobile devices for audio playback and recording (microphone and guitar/line-in input only).
  - Plug a USB storage device that contains playable audio contents into the USB-C port of the speaker (not for EMEA region).
- The speaker switches to the USB source automatically.  
 → Audio playback will start automatically.

### Tip:

- The speaker plays audio files on the USB storage device from the root folder to the last level of subfolders in alphabetical sequence. Up to 8 levels of subfolders are supported.

### Supported audio formats

Extension	Codec	Sample rate	Bitrate
MP3	MP1	44.1K/48K	32-448kbps
	MP2	44.1K/48K	8-384kbps
	MP3	44.1K/48K	8-320kbps
WAV	IMA-ADPCM	44.1K/48K	32-384kbps
	MS-ADPCM		
	a-law		
	u-law		
	PCM	44.1K/48K	128-1536kbps
FLAC	flac	44.1K/48K	600-1300kbps

## 6.2.1 Recording audio to USB storage device

1. Hold and **BASS BOOST** simultaneously for more than 2 seconds to start recording (microphone and guitar input only).  
 → When recording starts, the **BASS BOOST** LED flashes white once.
2. Repeat step 1 to stop recording.  
 → When recording stops, the **BASS BOOST** LED flashes white twice.

## 6.3 Music control

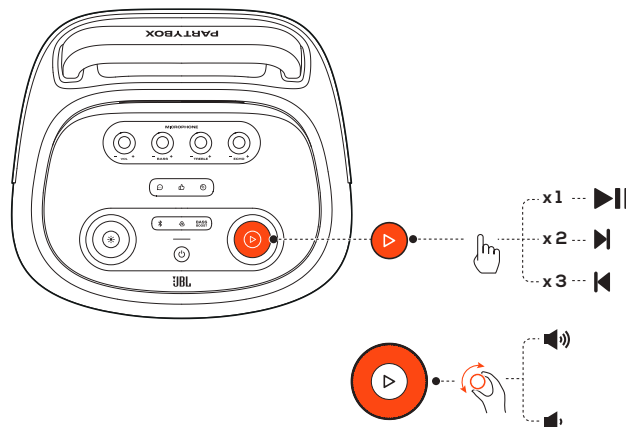

- Press once to pause or resume playback.
- Press twice to skip to the next track.
- Press three times to skip to the previous track.
- Rotate the volume knob clockwise or counterclockwise to increase or decrease the main volume.
- Press **BASS BOOST** to enhance the bass level: level 1, level 2, or off.

### Note:

- The skip operation is unavailable in AUX mode.

## 6.4 AUX connection

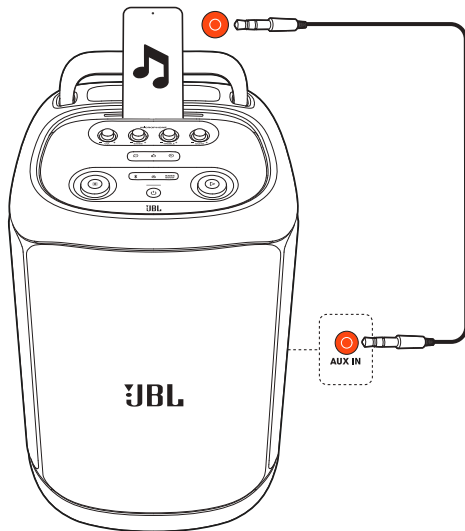

1. Connect an external audio device to the speaker through a 3.5 mm audio cable (not supplied).  
→ The speaker switches to the AUX source automatically.
2. Start audio playback on the external device.

## 6.5 Mixing sound with a microphone and / or guitar / line-in device

By using a microphone or electric guitar / line-in device, such as a DJ mixer (not supplied), you can mix sound with an audio source.

### Notes:

- Always set the volume of the guitar / line-in device or microphone to the minimum level before connection / disconnection.
- Always disconnect the guitar / line-in device or microphone when you are not using them.

### 6.5.1 Connecting a microphone

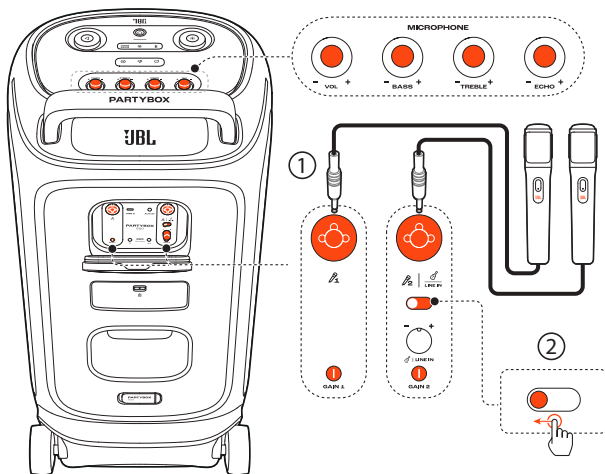

1. Connect a microphone to the MIC 1 or MIC 2 | LINE IN socket.

2. When connecting a microphone to the MIC 1 | LINE IN socket, switch the slider accordingly.

### 6.5.2 Connecting a guitar

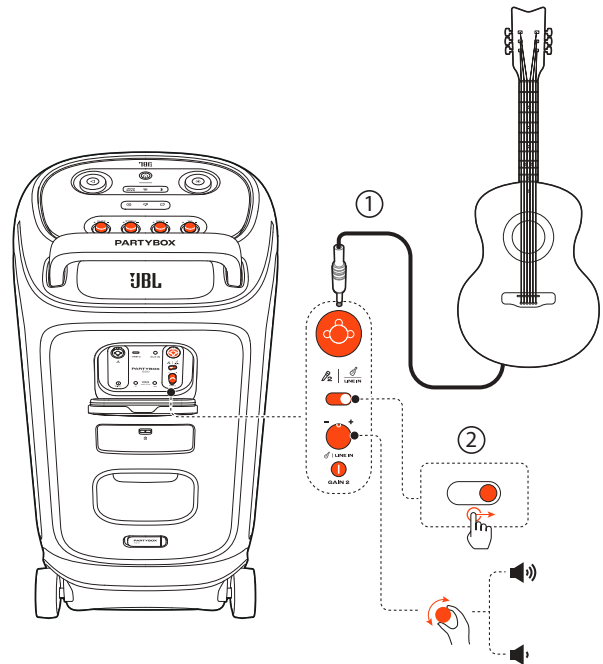

1. Connect a guitar to the LINE IN socket.
2. Switch the slider accordingly.

### 6.5.3 Connecting a line-in device

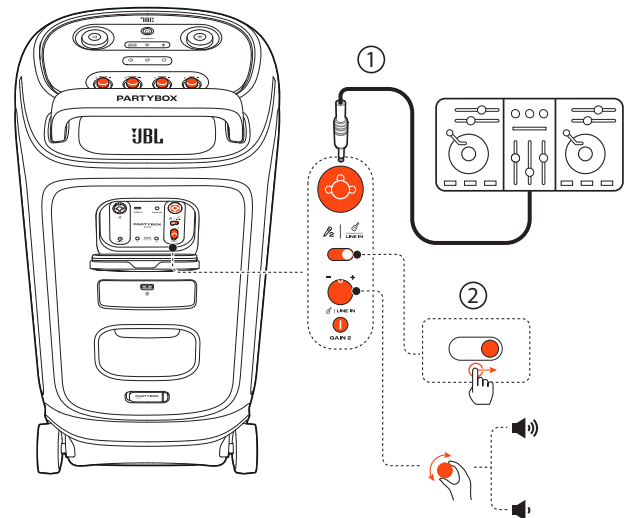

1. Connect a line-in device, such as a DJ mixer, to the LINE IN socket.
2. Switch the slider accordingly.

### 6.5.4 Mixing sound

Sing through the microphone or play the guitar / line-in device.

- To adjust the volume of the audio source, rotate the **▷** volume knob on the top panel clockwise or counterclockwise.
- To adjust the volume of the microphone, rotate the **- VOL +** knob on the top panel. To adjust the volume of the guitar / line-in device, rotate the **- GUITAR | LINE IN +** volume knob on the back panel.
- To adjust the gain of the microphone or guitar, rotate the **GAIN 1** or **GAIN 2** control on the back panel respectively.
- To adjust the echo, treble, and bass levels of the microphone, rotate the **- ECHO +**, **- TREBLE +**, and **- BASS +** knobs on the top panel respectively.

### 6.6 Charging your mobile device

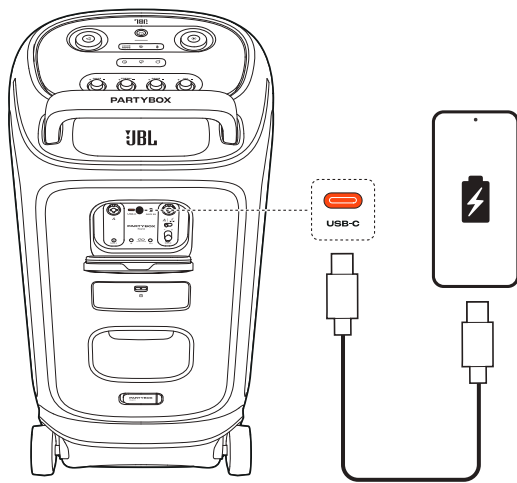

### 6.7 Replace battery (JBL BATTERY600)

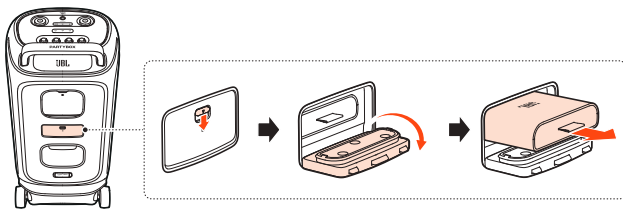

1. Pull down the latch to open the battery compartment, and then remove the old battery.

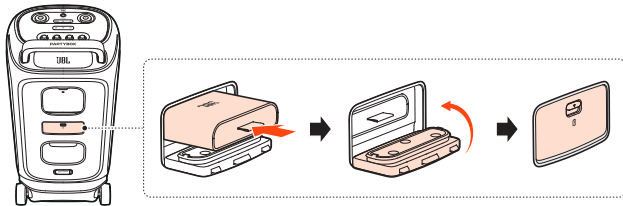

2. Insert a new battery of the same type (JBL BATTERY600) with the metal contacts facing down, and then close the battery cover.

## 7. CARRYING YOUR PARTYBOX

### Cautions:

- Before carrying the speaker, ensure that all the cords are disconnected.
- To avoid personal injury and/or property damage, hold the product firmly while carrying.

The telescopic handle design allows you to move the speaker around easily.

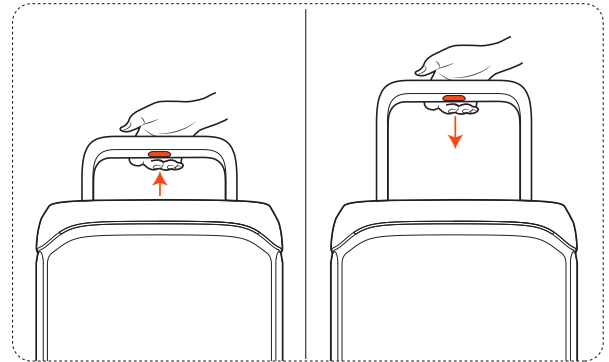

You can carry the speaker by holding both sides firmly when necessary.

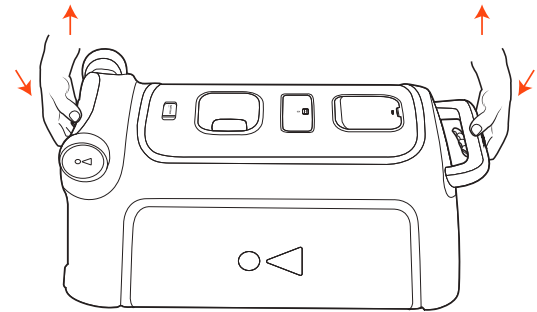

## 8. POLE-MOUNTING YOUR PARTYBOX

### Cautions:

- Installation must be done by qualified persons using safe rigging standards.
- The installer is responsible for proper selection and use of mounting hardware, to properly and safely pole-mount the speaker.

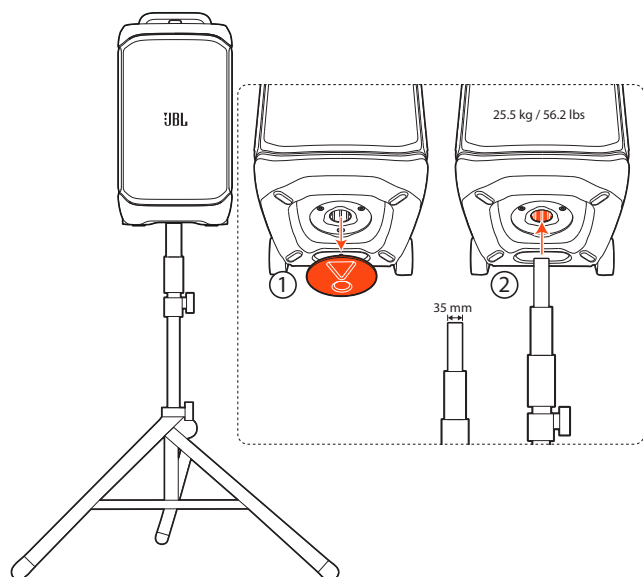

## 9. ADVANCED USAGE

### 9.1 JBL PARTYBOX app



Download and install the JBL PARTYBOX app to get more from the product.

### 9.2 Light effect

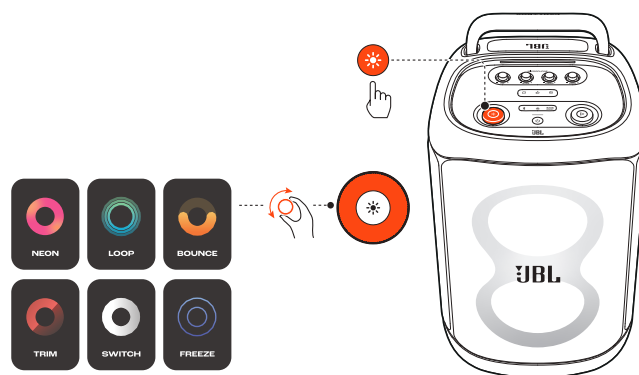

- Press to turn light effect on or off.
- Hold for more than 2 seconds to turn strobe and stary light on or off.
- Rotate the knob clockwise / counterclockwise to switch between different light patterns: NEON, LOOP, BOUNCE, TRIM, SWITCH, or FREEZE.

### 9.3 Sound effect

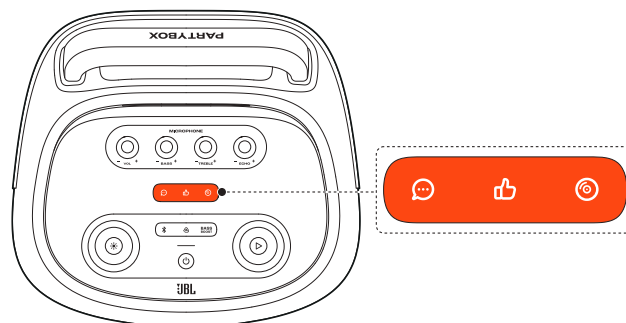

Press , , or to select a special sound effect.

## 9.4 Multi-speaker connection

You can connect two or more PARTYBOX speakers together for even bigger sound.

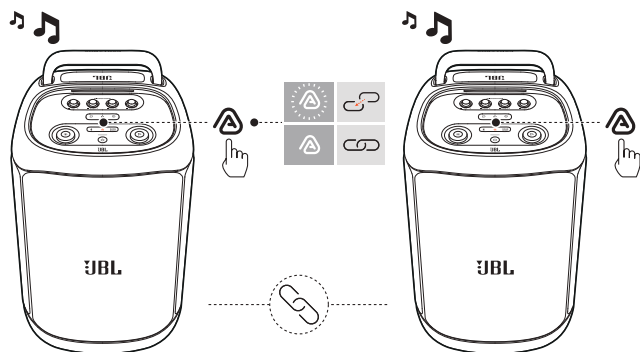

Press  on both speakers.

### To disconnect:

Power off or press  on either speaker.



### TIP:

- By default, the speaker connected to your Bluetooth device acts as the primary speaker.

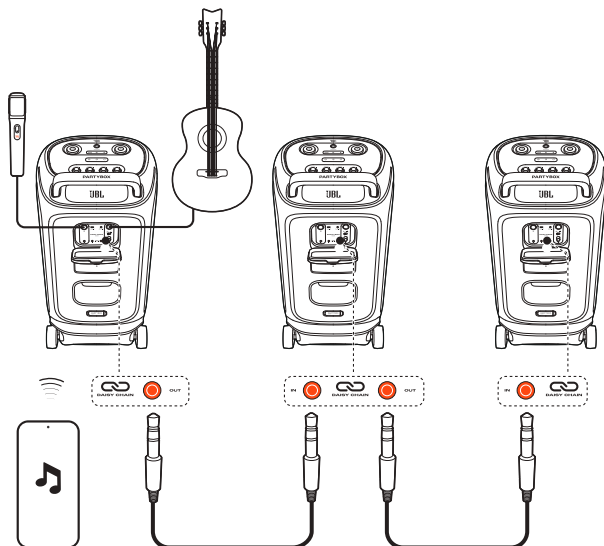
## 9.5 Daisy chain



## 9.6 Factory reset

To restore the factory settings, hold  and  for more than 10 seconds.

## 9.7 IPX4

### Cautions:

- Always keep the charging port dry before connecting AC power.
- To ensure splash resistance, always keep the protective covers closed securely.

The speaker is IPX4 splash resistant.

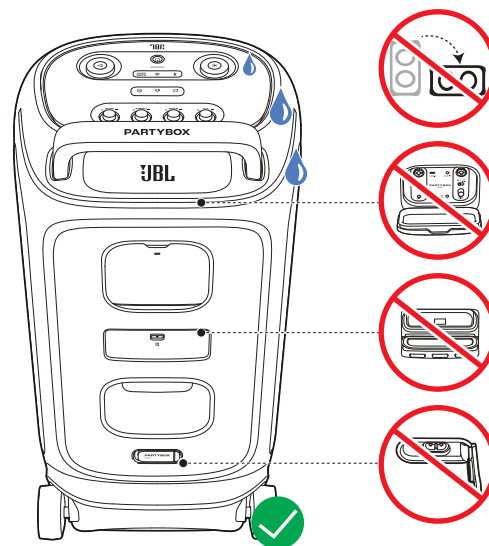

## 10. SPECIFICATIONS

- Transducer: 2 x 7.5 inch (208 mm) woofers, 2 x 1 inch (25 mm) dome tweeters
- Output power: 400 W RMS (IEC60268)
- Power input: 100 – 240 V ~ 50 / 60 Hz
- Frequency response: 40 Hz – 20 kHz
- Signal-to-noise ratio: > 80 dB
- Battery type: JBL BATTERY 600, Li-ion 99.02 Wh (equivalent to 21.6 V / 4584 mAh)
- Battery charge time: 3 hours (Speaker off mode)
- Music play time: up to 15 hours (varies by volume level and audio content)
- Cable type: AC power cable (type varies by regions)
- Cable length: 2.0 m / 6.6 ft
- USB-C charge out: PDO (5 V / 3 A, 9 V / 3 A, 15 V / 2 A, 20 V / 1.5 A), PPS (5 - 11 V / 2.7 A, 5 - 16 V / 1.85 A)
- USB format: FAT16, FAT32
- Bluetooth® version: 5.4
- Bluetooth® profile: A2DP V1.4, AVRCP V1.6
- Bluetooth® transmitter frequency range: 2.4 GHz – 2.4835 GHz
- Bluetooth® transmitter power: ≤ 18 dBm (EIRP)
- Bluetooth® transmitter modulation: GFSK, π/4 DQPSK, 8DPSK
- Supported formats (not for EMEA region): .MP3, .WAV, .FLAC
- Input sensitivity:
  - Aux-In: 250 mV RMS (3.5 mm connector)
  - Mic-In: 20 mV RMS
  - Guitar/Line-In: 100 mV RMS
  - Bluetooth/USB input: -12 dBFS
- Product dimensions (W x H x D): 415 x 769 x 369 mm / 16.34" x 30.28" x 14.53"
- Net weight: 25.5 kg / 56.2 lbs
- Packaging dimensions (W x H x D): 489 x 854 x 480 mm / 19.25" x 33.62" x 18.9"
- Gross weight: 29.4 kg / 64.8 lbs

\* 15 hrs battery playtime is only a reference and may vary depending on music content and battery aging after numerous charging and discharging cycles. It's achievable with a predefined music source, light show and bass boost switched off, volume level at 18 and Bluetooth streaming source.

## 11. TROUBLESHOOTING

### Caution:





- Never try to repair the product by yourself. If you have any problems while using this product, check the following points before you request service.

### System

#### The speaker will not turn on.

- Ensure that the speaker battery is not drained. If not, use the AC power instead.

#### No response from some buttons / knobs

- The product may be in demo mode. In demo mode, all the input sources and buttons, except  /  / **BASS BOOST** and the volume and light pattern knobs, are disabled. With AC power connected, hold  and  simultaneously for more than 10 seconds to exit.
- The top panel may be locked. In this case, all buttons / knobs on the top panel, except , are disabled. Access the JBL PARTYBOX app to unlock it.

### Sound

#### No sound from the speaker.

- Ensure that the speaker is powered on.
- Adjust volume.
- Ensure that a sound source is active and not muted.

### Bluetooth

#### A device cannot connect with the speaker.

- Ensure that the Bluetooth function of the device is enabled.
- The speaker is already connected with another Bluetooth device. Hold  on the speaker for more than 10 seconds to disconnect and pair with a new device.

#### Poor audio quality from a connected Bluetooth device

- The Bluetooth reception is poor. Move the device closer to the speaker, or remove any obstacle between the device and speaker.

---

## 12. COMPLIANCE

The product is in compliance with the European Union energy legislation.

### **Bluetooth connection mode**

The product is intended to be used for streaming music via Bluetooth connection. A consumer can stream Bluetooth audio to the speaker. When the product is connected through Bluetooth, the Bluetooth connection must remain active at all times to ensure proper operation.

The product will enter sleep mode (networked standby) after 20 minutes without operation. The power consumption in sleep mode is less than 2.0 Watts, after which it can be re-activated via Bluetooth connection.

### **Bluetooth disconnection mode**

The product will enter standby mode after 20 minutes without operation. The power consumption in standby mode is less than 0.5 Watts.

---

## 13. TRADEMARK



The Bluetooth® word mark and logos are registered trademarks owned by Bluetooth SIG, Inc. and any use of such marks by HARMAN International Industries, Incorporated is under license. Other trademarks and trade names are those of their respective owners.



HARMAN International Industries,  
Incorporated 8500 Balboa Boulevard,  
Northridge, CA 91329 USA  
[www.jbl.com](http://www.jbl.com)

© 2025 HARMAN International Industries, Incorporated.  
All rights reserved.

JBL is a trademark of HARMAN International Industries, Incorporated, registered in the United States and/or other countries. Features, specifications and appearance are subject to change without notice.